

## Contact

Online: [www.ezygym.com.au](http://www.ezygym.com.au)  
Click on 'contact us' button for renewals, pickups & support

Email: Queensland      [qld@ezygym.com.au](mailto:qld@ezygym.com.au)  
New South Wales      [nsw@ezygym.com.au](mailto:nsw@ezygym.com.au)  
Victoria      [vic@ezygym.com.au](mailto:vic@ezygym.com.au)

SMS: Queensland      0448 EZY GYM (0448 399 496)  
New South Wales      0488 EZY GYM (0488 399 496)  
Victoria      0409 EZY GYM (0409 399 496)

Phone: 1300 EZY GYM      (1300 399 496)

Post: PO Box 306  
Helensvale  
QLD 4212

Renewal Payment Options - Monthly or Quarterly

Direct Deposit:      Bank: Westpac  
Account Name: Ezy Gym  
BSB (Branch): 034 215  
Account No: 294 873

Reference Details:      Internet Banking: Full name & Suburb  
Branch Deposit: Last 6 digits of your phone number

Credit Card:      Phone: 1300 EZY GYM (1300 399 496)

Cheque or Money order:      Pay to: Ezy Gym  
Post to: Ezy Gym  
PO Box 306  
Helensvale QLD 4212

# Fit 100 / Fit 100 Assist Treadmill Manual

## CONTENTS:

1. Safety
2. Specifications
3. Control Panel
4. Treadmill Components
5. Assembly
6. Adjusting & Testing
7. Operating Instructions
8. Important Notes
9. System connection diagram
10. Maintenance
11. Running Belt Adjustment
12. Troubleshooting



## 10 - Maintenance

**Before cleaning or maintenance, please pull the power cable from the wall socket (not from the treadmill)**

1. **Cleaning:** The treadmill should be kept clean, preferably with a cover over the belt & motor cover. Clean it every one to two months. When cleaning, open the cover, clean the dust from motor and sensor and then check if the screws are loose.

If not used for a while make sure you clean the machine prior to use and run machine by itself to ensure that dust or foreign objects (insects) have not upset the sensor causing over speeding.

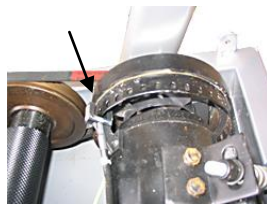

2. **Shoes:** Shoes should be soft and clean when running.

3. **Lubricate running platform:** Lift the running belt slightly and spray a silicon lubricant (any brand) evenly on the running platform beneath the belt on each side (every five hours of use).

## 11 – Running Belt Adjustment

The belt will stretch after time, necessitating adjustment. This is a normal function of the treadmill.

Belt tightness is determined by both the user's weight **and** speed combination. Only adjust the belt to suit the primary user's weight at their normal usage speed – casual user's differing weight and speed preference may cause the belt to slip.

**WARNING - OVERTIGHTENING THE BELT WILL CAUSE DAMAGE TO THE BELT AND MOTOR!**

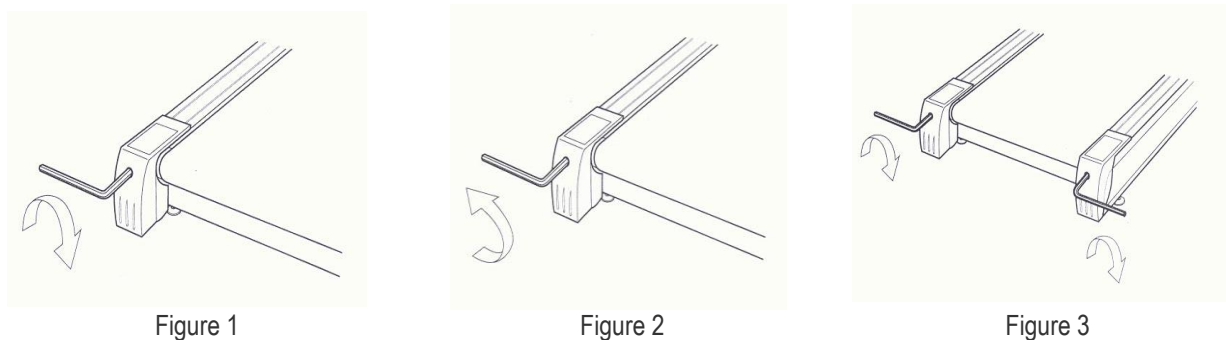

**The belt tension adjustment bolts are located on the center of each end cap as shown above.**

**1. Running belt has shifted to the left side. (Figure 1 - Adjusting the belt to right side)**

Keep the speed of belt at 3km. 1/4 turn the Left Rear Roller Adjustment Bolt to the clockwise direction.

Operating the running belt for a few minutes, check the movement of belt. Try to adjust until the running belt is centered.

**2. Running belt has shifted to the right side. (Figure 2 - Adjusting the belt to the left side)**

Keep the speed of belt at 3km. 1/4 turn the Left Rear Roller Adjustment Bolt to the count-clockwise direction.

Operating the running belt for a few minutes, check the movement of belt. Try to adjust until the running belt is centered.

**3. Running belt is slipping during use (Figure 3)**

Keep the speed of belt at less 3km. 1/4 turn the both Rear Roller Adjustment Bolt to the clockwise direction.

Check the belt tension if the running belt is still slipping.

## 2 - Specifications

- Input voltage: 220v  $\pm$  10% (50Hz or 60Hz)
- Environment temperature for working: 0-40°C.
- Maximum input power: 1.5 HP Electric current is less than 5A.
- Speed: 1.0 – 12.0 kilometers/hour ( $\pm$ 5%)
- Time limits: 00:00 - 99:99 (minute: second)
- Distance: 0.00 - 9.99 kilometers.
- Usable area running belt: 110 x 38 cm.
- Space requirement: 1.5 m x 1 m.
- Measurements : 152 x 70 x 41 cm.
- Manual Incline 3.5°
- 12 months Parts & Labour warranty - Made in China

## 7 - Operating instructions

1. Insert plug into power outlet.
2. Insert emergency stop "safety key" onto the "safety key" position of Control Panel.
3. Stand on the plastic side boards beside the running belt with hands holding the handlebars, and then start the machine by pressing Start/Stop button. The running belt's speed will show immediately (moving about 1.0 km/h.) Now start walking on the belt.

**Never start the machine while standing on the belt.**

4. Press the speed buttons to gain a suitable speed. The fastest speed is about 12.00 km/h.
5. Rub hands together several times and hold the pulse sensors. The Control Panel will display your heart rate.

**This is not a medical device, and as such indicates an estimate only.**

6. To monitor your distance, the Control Panel indicates distance traveled by 3 decimal units of a kilometer. i.e.: reading left to right shows – kilometre units, 100 metre units, 10 metre units.
7. To finish running, the treadmill will stop once the Start/Stop button is pressed. If you want to restart the treadmill, move your feet back to the sideboards, press Start/Stop button and follow the same procedure as in Point 3. There should be an interval of 3 seconds between stop and restart.
8. If you need to quickly stop the machine in case of emergency, the Treadmill will stop immediately if the safety key is pulled off the Control Panel.

**Only use this method of stopping in an emergency, use the Start/Stop button at all other times.**

USING PRESETS:

**You cannot stop the Fit 100 (Type A) machine during the P2 to P4 programs unless you pull the safety key.**

If you wish to follow a more structured exercise program (ensure you are fit enough to do so), you can use any of the three preset programs built into the machine. The following tables indicate the Time/Speed combinations of each preset.

Minutes used		1st	2nd	3rd	4th	5th	6th	7th	8th	9th	10th	11th	12th
P2:	km/h	3	3	6	3	6	3	6	3	6	3	3	3
P3:	km/h	5	8	5	10	6	11	7	12	6	5	5	5
P4:	km/h	5	5	8	9	10	9	10	11	12	8	5	5

## 3 - Control Panel - Fit 100 (Type B)

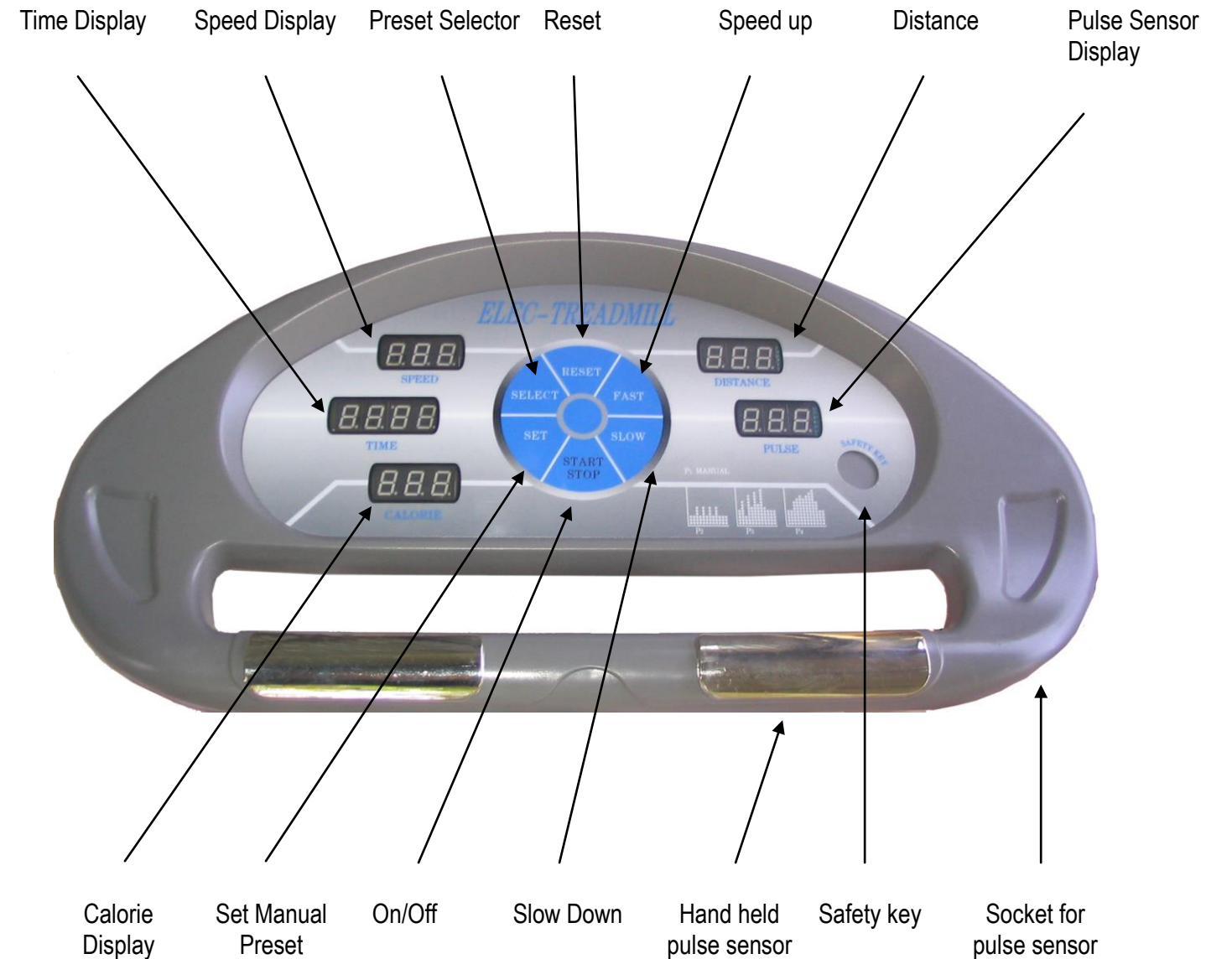

# 1 - Safety

**Attention: Carefully read this manual before using the machine.**

- The treadmill is for indoor use only. Keep it free from moisture and splashes of water. Don't put anything onto the machine.
- Keep the machine away from combustibles and flammables.
- Make sure that the four feet of the treadmill are firmly on the ground. If necessary, level the machine with pieces of carpet or rubber.
- Voltage should be within a range of 220-240 volts.
- The plug must be well grounded, and the power outlet must be capable of enduring electric currents more than 12 amperes. Avoid using other electrical appliances on the same power outlet line.
- Choose suitable sportswear and sports shoes for exercise. Never walk barefoot on the treadmill.
- Only one person (weighing up to 90kg's) at a time, may use the treadmill.
- Stand on the plastic side boards beside the running belt with hands holding the handlebars, then start the machine. Never start the machine while standing on the belt.
- Adjust the running speed according to individual needs.
- A frail person or someone suffering from heart disease should not use the treadmill without medical supervision.
- Continuous exercise time should not last longer than 60 minutes. Pull the plug from wall when not in use so as to avoid accidents.
- This treadmill is for domestic use only. Overuse may; damage the motor/controller, speed up aging of bearings and running belt/platform.
- Keep it in a clean environment. Dust can lower the sensitivity of the speed sensor.
- Maintain air humidity indoors in winter to avoid static electricity. Static may influence/damage the working of the electronics.
- The Treadmill Electronics should only be maintained by a qualified technician.

# 12 – Troubleshooting

Problems	Possible Reason	Check
Panel displays nothing when switched on	1.Plug & socket aren't well connected 2.Panel is not connected properly 3.Fuse is damaged	1.Reinsert plug 2.Reconnect Panel 3.Replace the fuse
The running belt stops while Panel working normally	The machine's over-load protection has been triggered or carbon brushes have seriously worn.	1. Restart the machine (press Start/Stop) 2. Pull out plug, then reinsert 1 minute later 3. Replace brush or clean dust.
1. Machine can't be started while Panel is working normally 2. Panel works normally, but there's noise after starting	The input voltage is too low or carbon brushes have seriously worn.	1. Adjust input voltage. 2. Replace brush or clean dust.
Working normally without any load, but belt stops when person step on	Belt is too loose	Tighten the belt
Panel works abnormally, no display, or button operation fails	Outside interference	Having eliminated outside interference, turn off power and restart 1 minute later
Only Panel works abnormally	Outside interference	Turn off power and restart 10 seconds later
Running & Panel works abnormally	Speed sensor dusty	Clean the dust
Error message E2 shows on display	Safety key not attached	Put safety key on magnetic patch on console
Error message E3 shows on display	Something wrong with display/power	Contact ezygym support
Error message E4 shows on display	Control card fault	Contact ezygym support
Error message E5 shows on display	Motor not working	Contact ezygym support
Error message E6 shows on display	Control Card too hot	Turn off, lubricate running deck, wait 30 minutes

### 3 - Control Panel - Fit 100 (Type A)

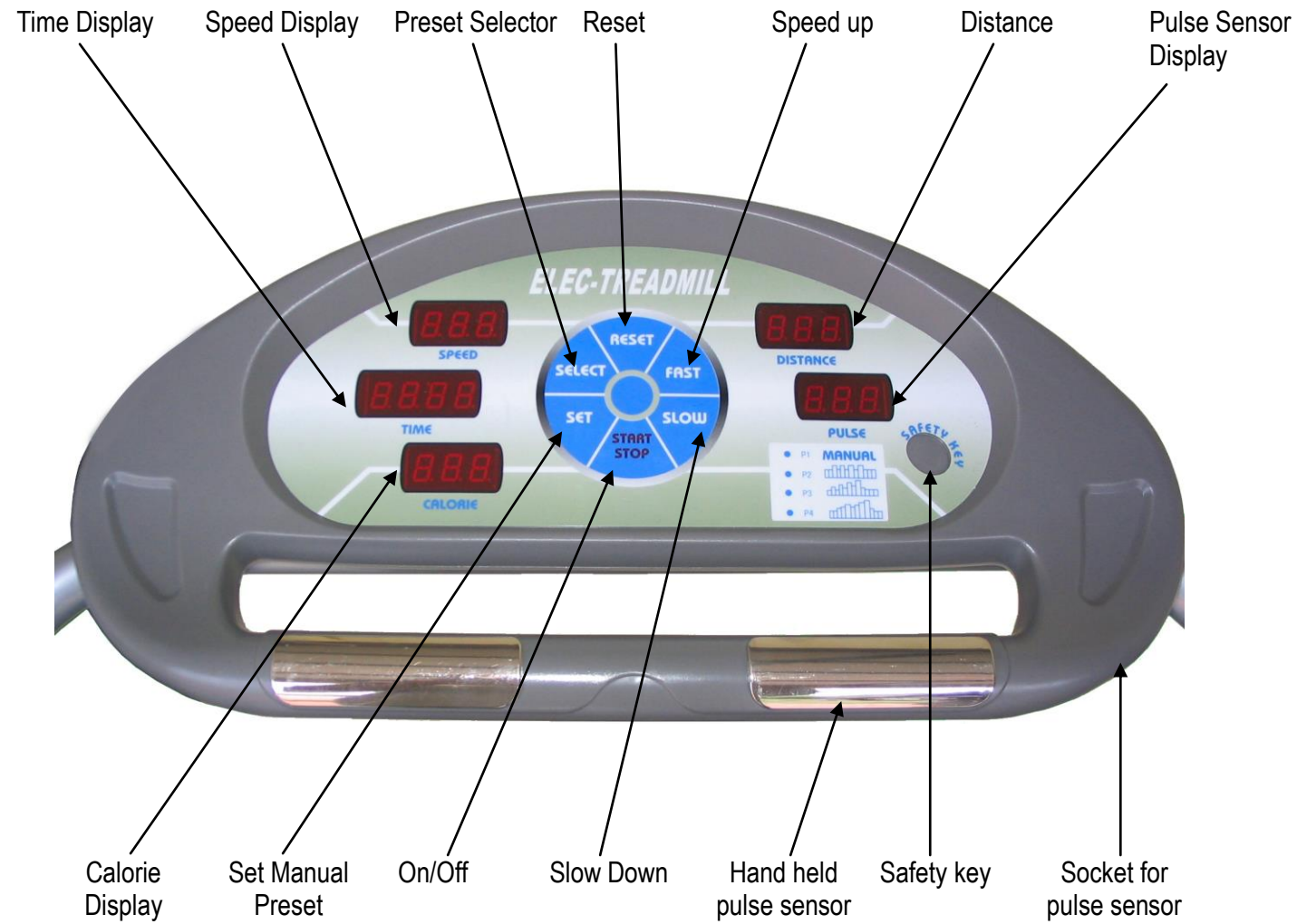

### 8 – Important Notes

1. When using the treadmill for the first time, please begin with a slow speed, and raise the speed gradually.
2. The strides should suit the speed of belt. Don't over stride.
3. Don't use the safety key as a stop button; otherwise the treadmill may be damaged. Only in case of emergency should the safety key be used.
4. The running speed and exercise time depend on the state of the individual's fitness.
5. If the power cable is damaged, do not use the machine (it should be changed by local agent).
6. Children, pregnant women, elderly/frail people etc. should take care using the machine.
7. Don't use the machine within one hour after eating a meal.
8. The pulse sensor is not a medical instrument; its data is for reference only.

### 9 - System connection diagram

The Treadmill Electronics should only be maintained by a qualified technician (fuses excepted).

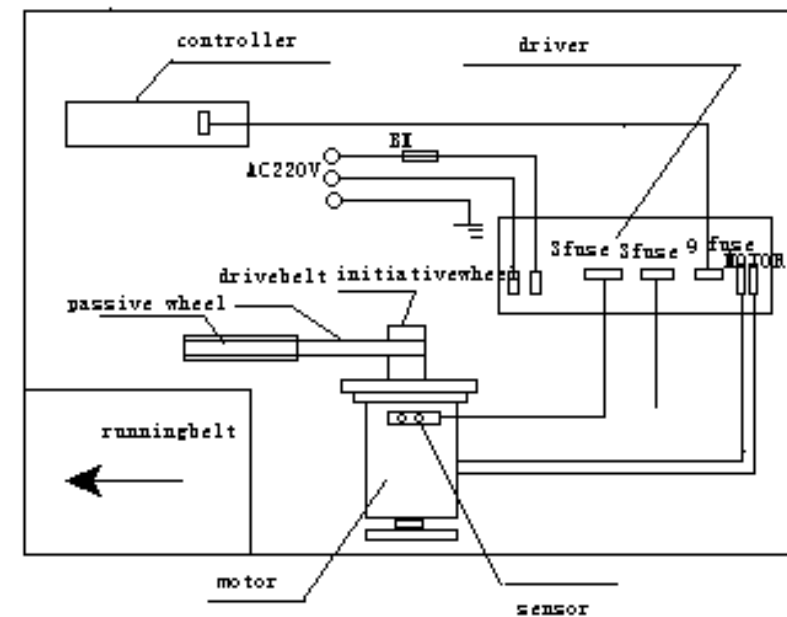

## 4 – Treadmill Components



### FIT 100 ASSIST: Extended Long Handle & Switch Option

The Start / Stop switch function is duplicated on the Fit 100 Assist extended right handle.

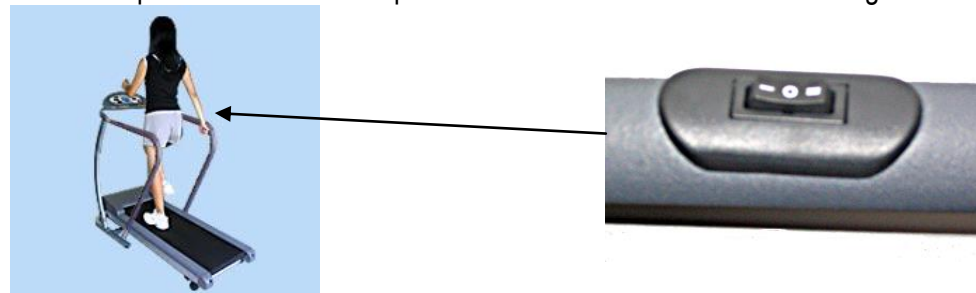

## 5 – Assembly

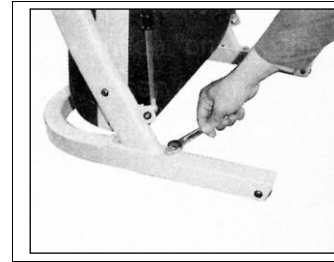

1. Insert left and right column tubes into bottom frame, fix with allen screws.

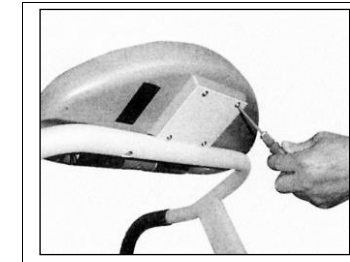

2. Screw Control Panel onto handlebar, connect signal cable and fix cable.

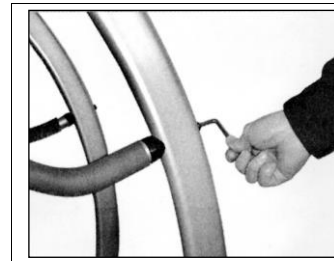

3. Fixed handlebars to the columns with allen screws.

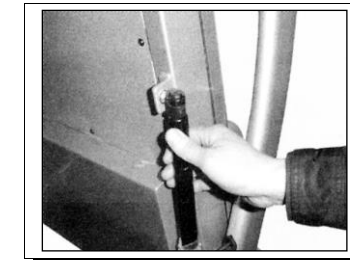

4. Fold the treadmill, then press one end of the spring onto ball head.

## 6 - Adjusting and testing

1. Put safety key onto Control Panel.
2. Please check the running belt moves smoothly and with no noise.
3. Plug in & turn on power outlet: Control panel should display "0" & the running belt is still.
4. Press the "on/off" button, the treadmill should start running with a low speed (1.0km/h).
5. Press the "fast" & "slow" buttons to check the speed controls.
6. Press the "on/off" button again, treadmill will stop, pull out the power plug.
7. Adjust the tilt of the Platform by pulling the Manual Incline Adjustor down from the Backplate.

